

SKYDROID 云卓

Quanzhou Skydroid Technology Co., Ltd.



*Tablet or mobile device not included

SKYDROID-T10 V1.0

User Manual

WARNING:

Misuse of this product may result in injury, damage or loss of property. Read the manual carefully before using this product. This item is not a toy. This item is intended for use by professional UAV operators and installers only. Do not use this product if you lack the knowledge and expertise to install and maintain UAV radio equipment. DO NOT use unapproved or unofficial components with this system. Operators must strictly follow the operation guides set forth in this manual. Skydroid does not accept any liability for the use or misuse of this product.

A.Description

1. Product features(Need buy separately)(Need buy separately)

① Dual antenna plus dual RF module with integrated control algorithms ensuring reliable communication via full angle high gain antennas. The T10 uses the Latest in FHSS (Frequency Hopping Spread Spectrum) technology to achieve perfect control and operation.

② Integrated with digital video transmission, farthest to 7KM.

③ Integrated with data transmission, farthest to 10KM.

④ Parameter adjustments via APP with upgraded traditional OSD to touch panel control.

⑤ Connected via Bluetooth or USB, also supports S.BUS、PPM、PWM、Serial ports and external devices, etc.

⑥ Connects the APP via Bluetooth, switching the operation model, adjusting the data of forward and reverse, rudder volume, channel binding, runaway protection value, SBUS, PPM output and digital baud rate. Providing parameter saving and loading functions.

⑦ Based on the "Tower"APP to ensure optimal compatibility with Pixhawk systems. A large map view allows for easy waypoint selection and route planning including one key return to home. The T10 Also supports Tower, QGC, JIYI, TOPXGUN and BOYING APP.

⑧ Using 2 pcs of 18650 batteries(Need buy separately),endurance over 25 hours with 20DBm transmission frequency.

⑨ High integrated datalink with video & data transmission and telemetry all in-one unit. Ultra-small size, with folding brackets, strong and stable.

⑩ A Number of optional cameras can be selected for your application, such as mini digital camera, digital camera with LED, 20 times zoom camera, etc.

2. Main application and range of usage

Specially designed for UAV, Helicopter, Fixed Wing, Multi Rotor or Boat operation. In video transmission (optional camera), Data Link and control of UAV.

3. TYPES, SPECIFICATION

PRODUCT DATA

Receiver data			
Model	R10	channels	10
Working voltage	4.5-5.5V	Working Current	100mA
Dimension	50*31*12(mm)	Weight	17 g

Controller data			
Model	T10	channels	10
Working voltage	4.2V	Working Current	100mA
Frequency	2.400-2.483GHz	Modulation	New FHSS
Firmware	APP online	Weight	525g
Dimension	160*150*50mm	Battery Capacitor	18650Batteries*2 <small>(Need buy separately)</small>
Duration	25(Hours)	Charge Port	MICRO-USB
Application	Helicopter,Fixed wing,Quadcopter,car,boat		

MINI Camera Specifications			
Model	MINIDCAM	Size	30*29*26mm
Working Current	180mA	Weight	15.6g

4. Order assignment

T10 Controller

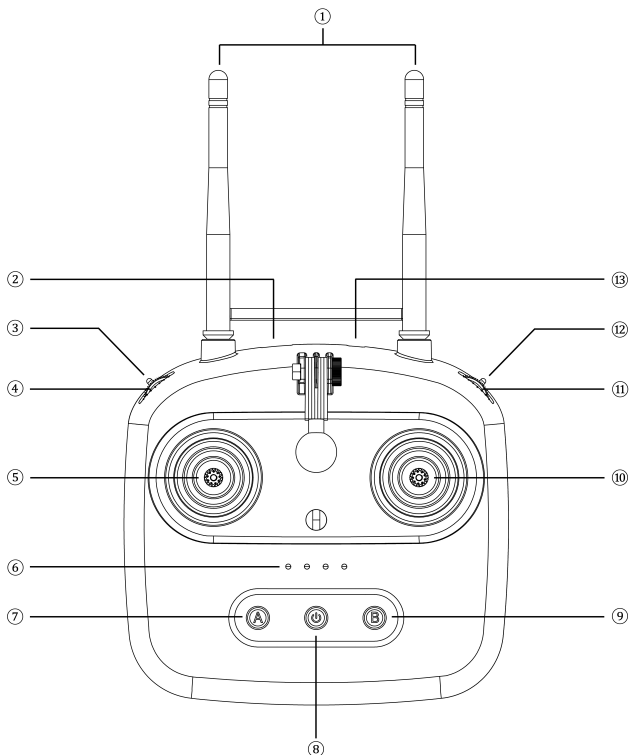

Number Description

Number	Description	Number	Description
1	2.4G 3dB Antenna	8	Power on/off button
2	USB1/video output	9	Button B
3	Three lever switch E	10	Right joystick X2、Y2
4	Jog wheel C	11	Jog wheel D
5	Left joystick X1,Y1	12	Three lever switch F
6	battery indicator①	13	Charging/data transmission
7	Button A		

① Battery Level LED definition ● ON ○ OFF

Battery Level LED definition				
●	●	●	●	75%-100%
●	●	●	○	50%-75%
●	●	○	○	25%-50%
●	○	○	○	0%-25%

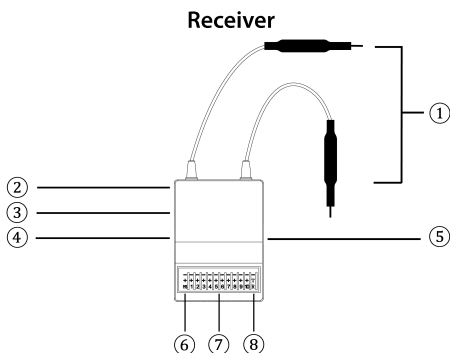

Port Description

Name	Description
1	Antenna
2	Power indicator
3	Pairing button
4	Firmware updating
5	Antenna
6	Power indicator
7	Pairing button
8	Firmware updating

Part List

Name	Qty	Remarks
T10 Main unit	1 piece	
R10 Receiver	1 piece	
MINIDCAM	1 piece	
Micro USB OTG cable	1 piece	For video transmission
Type C USB OTG cable	1 piece	For video transmission
Hexagon key	1 piece	For phone mount adjustment
Tools	1 piece	Change mode
Hanging strap	2 piece	
stick cap	2 piece	

Receiver indicator	Receiver status
Flashing in red	QC not passed, please return to factory
Red and green light rotates one time	QC passed
No green light on	No paired or main unit is off
Both color lights off	Checking the batteries' positive and negative

5. Environment Condition

PAY ATTENTION

- a) Environment Temperature: $-10^{\circ}\text{C} \sim +55^{\circ}\text{C}$.
- b) Storage Temperature: $-25^{\circ}\text{C} \sim +70^{\circ}\text{C}$.
- c) Relative Humidity: Do not exceed 85%.
- d) Atmospheric pressure: $86\text{kPa} \sim 106\text{kPa}$.
- e) Working environment should not contain explosive material or any corrosive or harmful gas that may cause interference in the operation of the product.
- f) Always work under shelter to prevent rain, snow, wind, sand and dust contamination.

6. Working Condition Power supply

Pay attention

The T10 main unit (ground terminal) uses two pieces of 18650 batteries, and compatible with the standard micro USB, 5v power adapter (such as mobile phone, camera and other digital products USB charger) to charge.

In case of smoke, heat or unusual an unusual smell during please stop charging the controller immediately and return to our company for servicing as soon as possible. Do not leave the product unattended while charging. Do not leave the product in a place where children can reach.

DO NOT charge when room temperature over 60°C .

7. Safety

WARNING

Beginners should pay attention for the following! Please read it carefully!

- ⊘ DO NOT fly under the influence of substances, or when tired!
- ⊘ DO NOT fly in strong wind and or rainy conditions!
- ⊘ DO NOT fly close to electric emission towers, communication stations and crowded area!
- ⊘ DO NOT fly nearby airports and other prohibited areas!
- ⊘ DO NOT fly around people or animals, or in any location where possible to damage property.
- ⚠ Check equipment before every flight and carry out maintenance and repairs as needed.
- ⚠ Use certified chargers to charge the batteries.
- ⚠ DO NOT put unnecessary force on antennas or electronic components to avoid damage.

B.Operation

Please connect Rx as below shown:

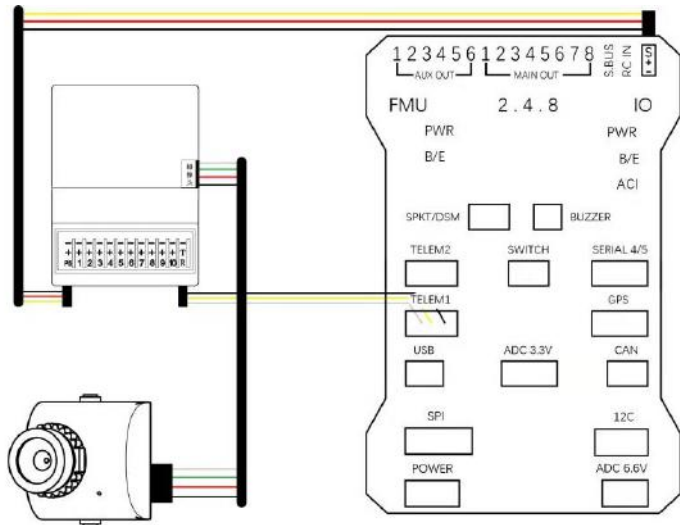

1. Pre-Check and Preparation

ATTENTION

- ① Check T10 battery level.
- ② Check position of the antenna to get better performance.
- ③ Make sure the firmware is the latest version.
- ④ DO NOT operate under the influence of alcohol or drug.

T10 part illustration Correct Position

Upright the antenna

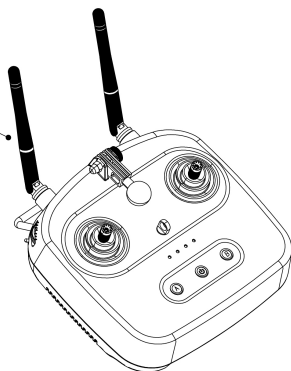

Incorrect operation

DO NOT put antenna parallel with the controller

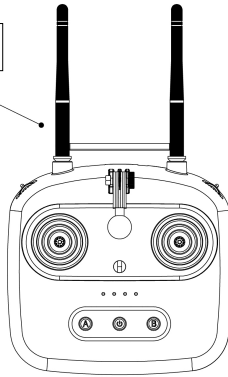

UAV Correct antenna position Correct Position

Place far from central board, upright the antenna without any obstacle

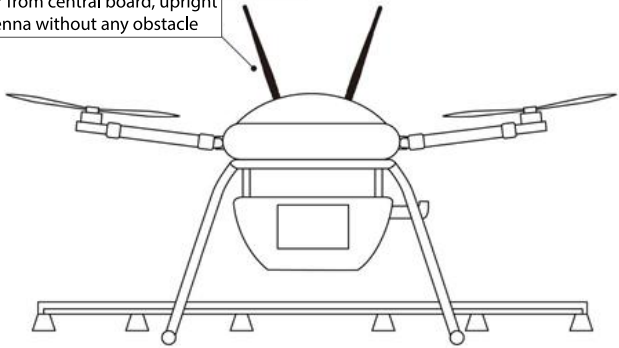

Or put under the drone arm

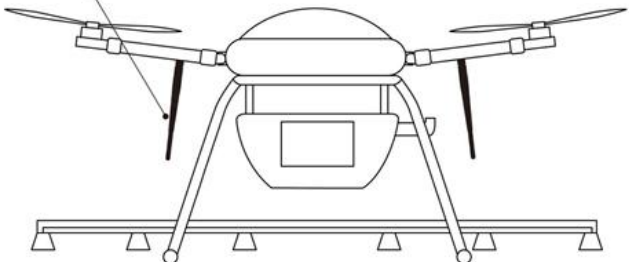

DO NOT put inside of the board

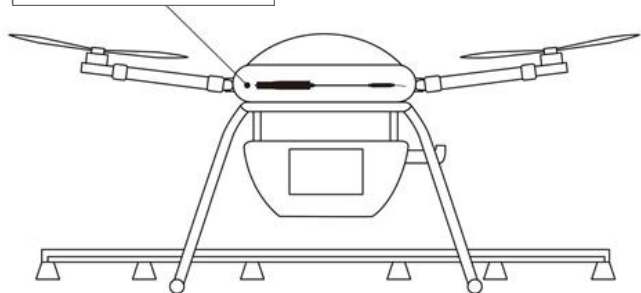

DO NOT place close to Carbon Fiber or Metal part

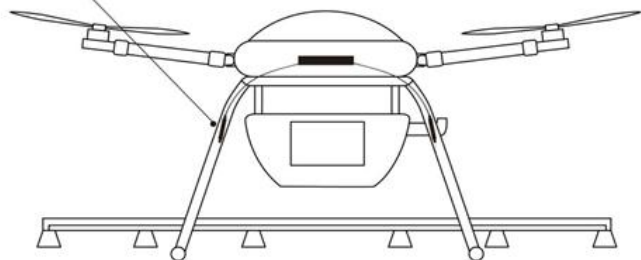

DO NOT cross the antenna between the central Flight control board and container

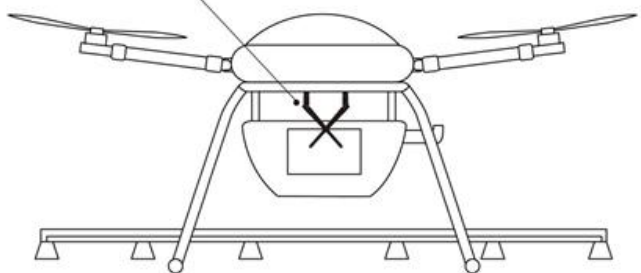

2. Operation

Part 1: Connect Device Helper

- 1) Confm receiver and flight controller are ready, power up to make sure the receiver is running normally.
- 2) Only support Android system.
- 3) Install APP (download from ofcial website www.skydroid.xin: Device Helper).
- 4) Turn on the T10 (long time press), turn on Bluetooth on the phone and search. Find: T10-XXX, select and enter the pairing code 1234, then the connection is successful.



(1)

Name	Purpose
Adjust Parameters	Adjust channel Nor/Rev, Channel binding, Failsafe value
Other Options	For selection of sbus,ppm output and baud rate
Hand Settings	Support 4 different types of hand mode
Update Device	For online firmware upgrade

- 5) Adjust parameter: enter controller interface. APP read the current data of controller and receiver.(Diagram 2).



(2)

Example:

Channel 1: X2 has no Rev, Failsafe value is set to be 1500, min travel is 1000, max is 2000.

Channel 2: Y2 has no Rev, Failsafe value is set to be 1500, min travel is 1000, max is 2000.

Channel 3: Y1 has no Rev, Failsafe value is 900, min travel is 1000, max is 2000.

Channel 4: X1 has no Rev, Failsafe value is set to be 1500, min travel is 1000, max is 2000.

.....and vice versa, view adjustment horizontally is much easier for setting. Just tick related item.

Attention

- ① Please select the value between 900-2100, Failsafe hold select "0".
- ② Please click SAVE at the right upper corner to keep the record. The selected

value will be written to the controller and receiver.

6) Save and download the data (Diagram 3,4,5).

In order to quicker change from model to model, or large scale set up, we can save the data in the APP so that you can find it out easily.

As illustrated: when finished the adjustment, click " " then Save Configuration. Then rename the model and save it. Same as download the data.

Attention: Adjusted parameter only save in the APP, Click "write" to load data to the controller. Sound "Di" means communication succeeded.



(3)



(4)



(5)

Part 2 : Receiver, Flight controller connection and set up

- 1) Binding: Press the pairing button on the side of the receiver and hold for 2 seconds, you can enter the pairing mode, then the green light will flashing. Meantime, turn on the main unit, can finish pairing. Once successful paired, the green indicate light will keep turning on.
- 2) Data link pin as illustrated, use attached wire or DIY connector to flight control board. Tx pin of receiver to Rx pin of Flight control board.

Part 3 : T10 Connect to Android phone

- 1) Connection between receiver and camera (example: mini digital camera), Power up the system. Please watch the video of connection in www.skydroid.xin.
- 2) Please go to www.skydroid.xin to download the Skydroid FPV.
- 3) Using Bluetooth to connect the T10 and the display (Please check the part No.1).
- 4) Click "Yes" to confirm then image will show on your phone.
- 5) Use of Skydroid FPV please go to the official website.

Part 4: How T10 connect to PC missionplanner, QGC

- 1) Use two USB connectors cable to link between USB1 and USB port in PC. Select the port related to the ground station. Please select Baud Rate 115200 to link with the data port of the flight controller. (QGC, missionplanner need to add SDK of Skydroid to show image, undevelopment).
- 2) Use Micro data cable to connect USB2 and PC, select baud rate 57600 (Only support data, not for video).

Part 5: How T10 to update firmware

1) Android update

Download and install Device Helper before upgrade.

2) T10 upgrade: connect T10 with the phone via Bluetooth, please check the part no.1.

Turn of the main unit, press and hold the button "A", and long time press the power button to turn it on, you will find button "A"'s light flashing slowly, which means, it is downloading. Meanwhile, open the Skydroid Device app to click "updating", choosing update the controller, and click "checking updating", if there's new firmware released, please click "update at once".

3) R10 update: connect R10 with the phone via Bluetooth, please make sure the main unit is turning on and paired with R10 (green indicate light turning on).

Open the Skydroid Device app to click "updating", choosing update the receiver, and click "checking updating", if there's new firmware released, please click "update at once".

Part 6: Q & A

Q: What is the Video/Data distance of T10 in transmission?

A: Under an open area, the max distance of video link is 7km while data link is 10km.

Q: Does T10 support ppm, sbus?

A: Yes! Sbus port is defaulted in the frst row. If you need ppm signal which can be switched in Device Helper App.

Q: How to defne two antenna on T10?

A: Two antenna are 2.4ghz redundant design. We use diversity technology so both antenna perform data link and transimission.

Q: How to defne two antenna on receiver?

A: Two antenna on Receiver are redundant design and telemetry.

Q:How to charge T10?

A: Use micro USB cable come with T10. Please use certified 5v charger. LED status: LED fashing during charging and of when it is full.

Q: Where to watch demonstration video of T10?

A: Please visit <http://www.skydroid.xin> and watch the video.

Q: How to power on/of the T10?

A: long press the power switch.

Q: No LED indication on the receiver when plug into the fight control board?

A: T10 is power of; if the case still exist, check battery status(short press power switch to check the battery level), if not binding, then bind it.

Q: How to change Mode?

A: Monitor system linked up with the radio by Bluetooth, then open Device Helper to select mode 1 or mode 2 and saved. No need to set the others.

Q: How to calibrate neutral of the gimbal?

A: Calibration (watch video), please visit www.skydroid.xin.

Q: How many times of command being send out per second?

A: 300 times per second.

Q: Does T10 bind with new receiver?

A: T10 send binding signal with ID to bind a new receiver. Once binded the new one, old receiver need to rebind afterwards.

Q: what is the definition of the sound buzzer?

A: 3 short beep-power on. 4 short beep- binding succeeded,continues short beep-battery low level; slow continues beep-receiver not turn on or disconnected.

C. Maintenance, Servicing

Storage for not using certain period

Put T10 a dry and ventilated area. No direct Sun light to prevent harm to the internal Lipo battery. If store it over three months, it is highly recommended to put room temperature between 22C to 28C. DO NOT put it below 20C or higher than 45C area.

D. Transportation, Storage

WARNING

In order to prevent lost or getting hurt, Please strictly follow the rules of operation: Keep small parts or wire away from children can reach. DO NOT let children touch the small parts of T10.

ATTENTION

- 1) DO NOT put T10 into water. If it does, please switch of the power and dry it.
- 2) DO NOT crash the T10 or break the battery is prohibited.

E. Scan the QR code to download the APP

If download failed,search www.skydroid.xin



Device Helper



Skydroid FPV



Skydroid Tower

Device Helper—in use of adjustment of radio parameter, frmware upgrade, save models, mode change, etc.

Skydroid FPV—in use of linking Skydroid video, foating window can be top of others App(need to turn on foating window feature in Android system), use for VR, Video capture and Data rate adjustment).

Skydroid Tower—optimised by tower 4.0, can connect to mavlink protocol of APM,

PX4 flight controller to realise waypoint data telemetry. Also has video serial port (similar to DJI go).

ATTENTION

You need to wire connect with the Skydroid FPV to open the floating window. Activate QGC and connect with bluetooth to start telemetry. In the future, when QGC join Skydroid SDK then the operation will be as simple as Skydroid Tower. No need to connect bluetooth and no need to multiply another APP on QGC. Very simple. Highly recommend to use Skydroid tower.

FCC Statement

This equipment has been tested and found to comply with the limits for a Class B digital device, pursuant to Part 15 of the FCC Rules. These limits are designed to provide reasonable protection against harmful interference in a residential installation. This equipment generates uses and can radiate radio frequency energy and, if not installed and used in accordance with the instructions, may cause harmful interference to radio communications. However, there is no guarantee that interference will not occur in a particular installation. If this equipment does cause harmful interference to radio or television reception, which can be determined by turning the equipment of and on, the user is encouraged to try to correct the interference by one or more of the following.

measures:

- Reorient or relocate the receiving antenna.
- Increase the separation between the equipment and receiver.
- Connect the equipment into an outlet on a circuit diferent from that to which the receiver is connected.
- Consult the dealer or an experienced radio/TV technician for help.

This device complies with part 15 of the FCC Rules. Operation is subject to the following two conditions:

- (1) This device may not cause harmful interference.
- (2) This device must accept any interference received, including interference that may cause undesired operation.

Changes or modifications not expressly approved by the party responsible for compliance could void the user's authority to operate the equipment.

SKYDROID 云卓
Quanzhou Skydroid Technology Co., Ltd.



Facebook



YouTube

www.skydroid.xin

SKYDROID 云卓

泉州云卓科技有限公司



*产品不含显示设备

云卓-T10 V1.0

使用说明书

注意:

本产品使用以下词条因操作不当可能带来的潜在危险加以分级说明。

注意: 如果不遵循说明进行操作,可能会导致财产损失和轻微伤害。

注意: 如果不遵循说明进行操作,可能会导致财产损失、重大事故和严重伤害。

警告: 通过阅读整个用户手册,熟悉产品的功能之后再进行操作。如果没有正确操作本产品可能会对自身或他人造成严重伤害,或者导致产品损坏和财产损失。本产品较为复杂,需要经过一段时间熟悉后才能安全使用,并且需要具备一些基本常识后才能进行操作,如果没有强烈的安全意识,不恰当的操作可能会导致产品损坏和财产损失,甚至对自身或他人造成严重伤害。本产品不适合儿童使用。切勿使用非云卓提供或建议的部件,必须严格遵守云卓的指引来使用产品。

一、概述

1. 产品特性

- ① 双天线冗余设计,配合通讯算法,极大增强了信号的通讯能力。FHSS扩频技术,全角度增益天线,通信距离内完成飞行器与相机的各种操作和配置。
- ② 集成数字视频传输功能,可实现最远7KM传输。
- ③ 内部集成数传电台,可实现最远10KM传输。
- ④ 安卓APP设置参数,把传统的OSD设置参数升级为触屏操控。
- ⑤ 蓝牙和USB两种连接方式,同时支持S.BUS、PPM、PWM、串口等多种口,并支持设备扩展。
- ⑥ 通过蓝牙连接APP,切换手型,调整反向、舵量、通道绑定、失控保护值、SBUS、PPM输出和数传波特率等数据。提供参数保存和载入功能。
- ⑦ 支持TOWER、QGC、JIYI、TOPXGUN、BOYING等APP。
- ⑧ 使用两节18650电池(需另购),续航约25小时,20dBm发射功率。
- ⑨ 高集成度数图控三合一链路。超小体积,采用折叠支架,结实稳固。
- ⑩ 可选配多种SKYDROID推出的摄像头,如MINI数字摄像头、带灯数字摄像头、20倍变焦摄像头等。

2. 主要用途及适用范围

用于遥控操作直升机、固定翼、多旋翼、车、船等进行视频图像传输、数据传输和操作无人机飞行。

3. 品种、规格

产品参数

遥控器参数			
型号	T10	通道数	10
工作电压	4.2V	工作电流	100mA
频段	2.400-2.483GHz	跳频	全新FHSS跳频
升级	APP在线升级	重量	525g
尺寸	160*150*50毫米	电池	18650电池*2(需另购)
续航时间	25小时	充电接口	MICRO-USB
应用	直升机、固定翼、多旋翼、车、船		

接收机参数			
型号	R10	通道数	10
工作电压	4.5-5.5V	工作电流	100mA
尺寸	50 *31 *12 mm	重量	17g

MINI摄像头			
型号	MINIDCAM	尺寸	30x29x26 mm
工作电流	180mA	重量	15.6g

4、型号的组成及其代表意义

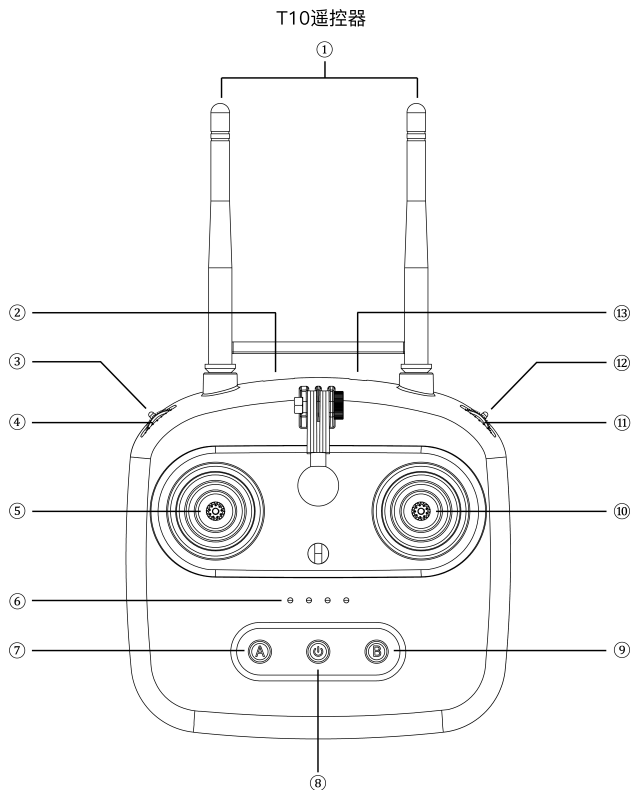

各按键代表的含义

序号	注解	序号	注解
1	2.4G 3dB 天线	8	开关键
2	USB1/图像输出	9	按键 B
3	拨动三档开关E	10	右摇杆 X2、Y2
4	拨轮 C	11	拨轮 D
5	左摇杆X1、Y1	12	拨动三档开关 F
6	电量指示灯①	13	USB2 /充电/数据传输
7	按键 A		

①注：电量灯的定义：

●开 ○关

遥控器电量指示灯				
●	●	●	●	75%-100%
●	●	●	○	50%-75%
●	●	○	○	25%-50%
●	○	○	○	0%-25%

接收机

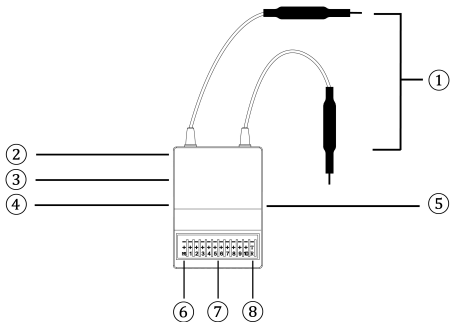

各接口注释

名称	备注
1	天线
2	电源指示灯
3	对频按钮
4	USB升级口
5	摄像头接口
6	PPM/Sbus
7	PWM
8	数传接口 \ G-GND T-TX \ R-RX

配件表

名称	数量	备注
T10主机	1台	
R10接收机	1台	
MINIDCAM	1台	
数传线	1根	用于数据传输
Usb-Micro otg 线	1根	用于图像传输
Usb-Type c otg 线	1根	用于图像传输
改手配件	1套	用于修改摇杆姿态
挂带	1根	
摇杆帽	2个	

接收机状态指示灯	接收机状态
红灯快闪	自检没过，请重试或返厂
红绿灯交替亮一次	自检通过
绿灯不亮	未对频或遥控器未开机
红绿灯均不亮	检查供电与接线正负极

5、使用环境条件

注意

- 环境温度：-10°C~+55°C
- 贮存温度：-25°C~+70°C。
- 相对湿度：Not exceed 85%o
- 大气压力：86kPa~106kPa。
- 使用地点不允许有爆炸危险的介质，周围介质中不应含有腐蚀金属和破坏绝缘的气体及导电介质，不允许充满水蒸气及有严重的霉菌存在。
- 使用地点应具有防御雨、雪、风、沙、灰的设施。

6、工作条件

供电方式和注意事项

T10系列地面端使用两节18650电池，兼容市场标准micro USB接口5v规格的电源适配器（例如手机、相机等数码产品USB充电器）进行充电。

如在地面端充电时遇到冒烟、有异味、漏液的情况下时，请勿继续给地面端充电，请移送至本公司进行维修。

请勿在婴儿触碰区域给本产品进行充电，以免发生触电危险。请勿在超过60°C的环境下对本产品进行充电。

7、安全

警告

初学者请特别注意以下安全事项！请细读！

- ⊗ 禁止在疲劳、醉酒等身体状态不佳时飞行！
- ⊗ 禁止在下雨、强风等恶劣天气时飞行！
- ⊗ 禁止在接近高压线、通信基站、有人聚集或者活动的场所飞行！
- ⊗ 禁止在机场和其他明令禁飞的地方飞行！
- ⊗ 禁止在人群集中的地方、停车区域或者其他可能造财产损失或者人身伤害的区域操控飞行模型
- △ 飞行前，做好飞行器的设备检测，检查收发系统与飞行器是否正常；
- ① 请使用有保障的专业充电器为电池充电。
- ① 本产品天线为脆弱部件，避免受力过度破坏。

二、使用、操作

接收机连线方法如图所示：

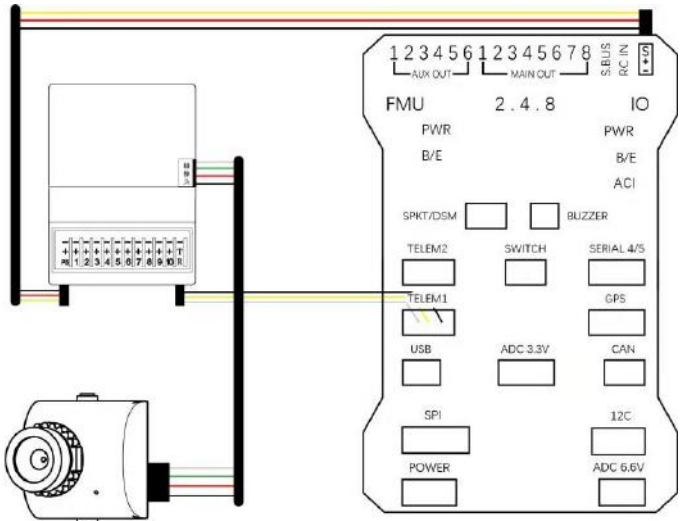

1、使用前的准备和检查

注意

- ① 使用前务必先检查遥控器电量是否充足。
- ② 使用前请检查天线是否按要求摆放，已获得最佳效果。
- ③ 首次使用请确保固件已经升级至最新版本。
- ④ 用户应确保自己不在醉酒、药物影响下操作使用。

遥控器操作示意图

正确操作

展开并垂直朝上

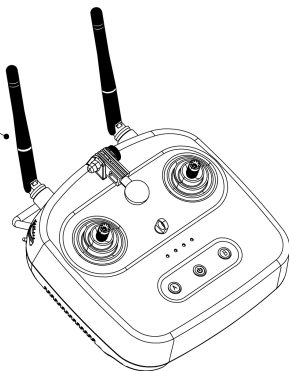

错误操作

不能与遥控机平行

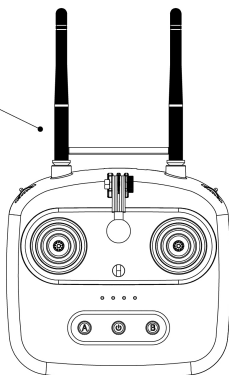

无人机操作示意图

正确操作

远离中心板，垂直向上，无遮挡

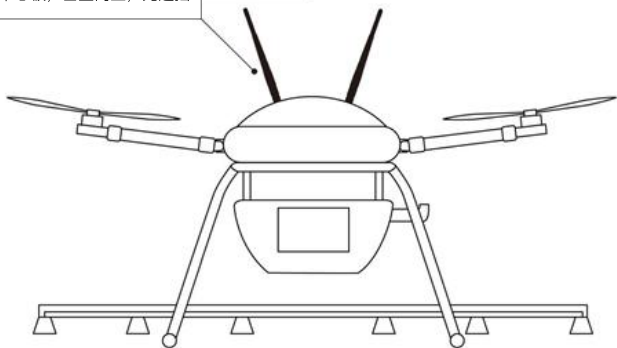

固定于机臂下方

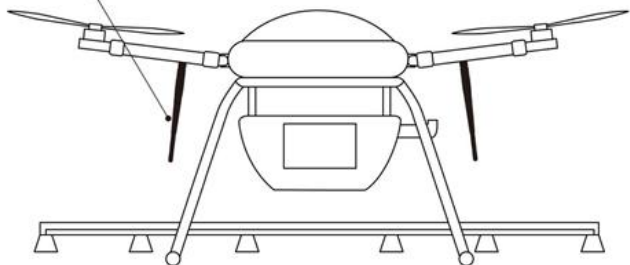

错误操作

不能放于中心板内部

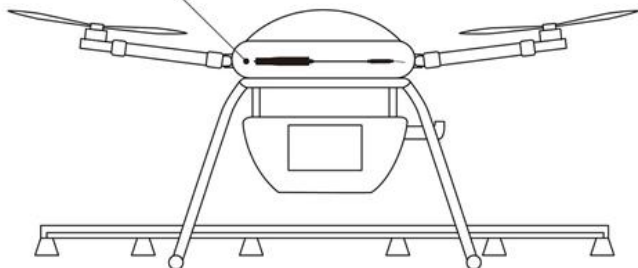

不能靠近碳纤维和金属

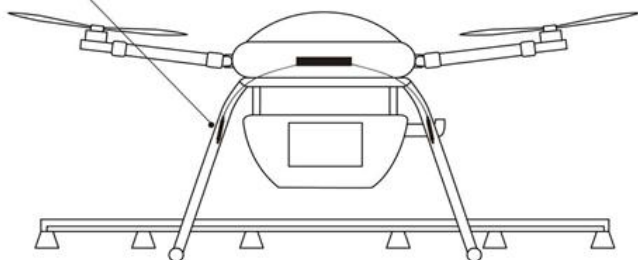

天线不能交叉，不能放于中心板与水壶中间

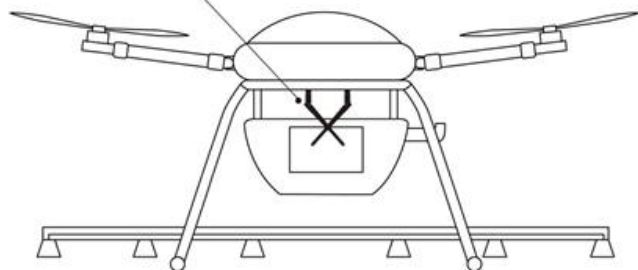

2、使用方法

第一部分连接手机调参APP

- 1) 装机后确认接收机已经安装就位，并通电，确保接收机正常工作。
- 2) 在安卓手机安装APP，后面括号里面的不修改（请到官方网站www.skydroid.xin下载：设备助手）。
- 3) 遥控开机（短按+长按,关机同理）。
- 4) 遥控器开机（长按），手机系统设置打开蓝牙并搜索。找到：T10-XXX，选择并输入配对码1234，连接成功。



(1)

名称	用途
参数调节	用来调整通道正反向、舵量，通道 绑定、失控保护值
其他选项	用于选择接收机 SBbus、PPM 输出，和数传波特率
MOD 切换	支持 4 种 MOD 可以自由切换
设备升级	用于在线更新固件

5) 参数调节的方法进入参数调节界面, APP会读取遥控和接收机的当前数值(如图二)。



(2)

例如:

通道 1: 绑定的是X2, 无反向, 失控保护值是1500,最小舵量是1000,最大舵量是2000。

通道 2: 绑定的是Y2, 无反向, 失控保护值是1500,最小舵量是1000,最大舵量是2000。

通道 3: 绑定的是Y1, 无反向, 失控保护值是900,最小舵量是1000,最大舵量是2000。

通道 4: 绑定的是X1, 无反向, 失控保护值是1500, 最小舵量是1000,最大舵量是2000。

.....以此类推。最好手机横屏更加直观如需调整, 请跳入相关值, 或者勾选即可。

注意

- ① 失控保护值请选900-2100之间的数值, 失控保持请填“0”
- ② 调整完参数后, 需点击右上角保存, 值将会被写入遥控器和接收机。

6) 配置保存和载入(如图三、四、五)。

为了方便更换机型, 或者批量配置。我们可以把配置保存在APP内部。每次只要载入配置, 并对遥控进行保存操作就可以快速实现配置。

如图示意: 调整好参数, 点击右上角“, 二出现菜单, 选择保存。

自定义名称进行保存即可, 载入参数同理。

注意: 参数只是保存在app,如需写入遥控器请点击“保存”, 遥控通讯成功会“滴”响一声。



(3)



(4)



(5)

第二部分接收机, 飞控接线和设置

1) 对频:

按住接收机侧对频按钮2秒进入对频模式, 指示灯绿灯快闪。此时遥控开机即可完成对频, 对频成功后指示灯绿灯处于常亮。

2) 数传引脚如图所示, 请根据配线焊接或DIY插入飞控。接收机TX对应飞控RX, 接收机RX对应飞控TX。

第三部分：T10如何连接手机显示图像

- 1) 连接接收机与摄像头（以MINI数字摄像头为例），并给设备上电。接线方法请参考接线图或到官方网站www.skydroid.xin观看视频。
- 2) 安装“SKYDROID FPV”。请到官方网站www.skydroid.xin下载。
- 3) 遥控器使用蓝牙连接手机。（参考第一部分）
- 4) 在弹出的USB窗口点击确定，即可显示图像。
- 5) “SKYDROID FPV”使用方法请参考官网视频。

第四部分：T10如何连接电脑Missionplanner、QGC等

- 1) 使用双头USB连接线连接USB1和电脑USB，地面站选择对应端口，波特率选择115200即可连接数传接口对应的飞控（如需显示图像需要QGC、missionplanner加入skydroid的SDK支持，开发中）。
- 2) 使用micro数据线连接USB2和电脑，波特率选择57600，（仅支持数传，不支持图像）。

第五部分：T10如何固件升级

- 1) 安卓升级。
升级前请下载设备助手并安装。
- 2) 遥控器升级：手机连接遥控器，连接方式选择蓝牙，参考第一部分。
将遥控关机，按住“A按键”然后长按开机键开机，遥控器A按键指示灯慢闪进入下载模式。此时打开设备助手，点击升级设备，选择升级遥控器，点击检查更新，如果有新固件请点击立即升级。
- 3) 接收机升级：手机连接遥控器，连接方式选择蓝牙。遥控器开机，接收机请保持与遥控器 已对频并通电（绿灯长亮）。
打开设备助手，点击升级设备，选择无线升级接收机，点击检查更新，如果有新固件请点击立即升级。

第六部分：常见问题与解决办法

- 1: 云卓T10图传，数传距离能到多远？
答：室外无遮挡无干扰情况下，图传最远可达7KM距离，数传最远可达10KM距离。
- 2:云卓T10接收机支持PPM、SBUS么？
答：支持！默认情况下，第一排为SBUS信号接口。如果想使用PPM信号，可在“设备助手”里切换。
- 3: T10主机上的两根天线如何定义的？
答：2根都是2.4g,冗余关系，负责发射和接收数传控制和图像。使用分集技术，任何一根天线都可以单独工作。
- 4: T10接收机上的两根天线如何定义的？
答：接收机采用的是双天线冗余设计，两根天线同时接收主机信号，也同时发射回传信号。飞行时建议让两根天线叉开一定角度，获得更好的接收效果。
- 5: T10如何充电？
答：使用T10自带的micro OTG数据线或者安卓micro数据线，并使用合格的5V充电器进行充电。充放电指示灯：充电闪烁，充满灯灭。
- 6: T10如何观看视频演示？
答：请访问云卓科技官方网站<http://www.skydroid.xin>。
- 7: 遥控器如何开关机？
答：长按开关机。
- 8: 接收机插在飞控上灯不亮？
答：遥控器未开机。若遥控器已开机，请检查接收机电源是否正常，或尝试重新对频。
- 9: 切换美国手、日本手？
答：遥控器通过蓝牙连接显示设备，打开设备助手APP,进入手型设置，选择美国手日本手，然后保存，其他不需要设置。
- 10: 摇杆电位器中位值校准？
答：校准电位器（见视频），参考官网www.skydroid.xin。
- 11: 固定的遥控指令每秒发送多少次？
答：每秒300次。

12: T10遥控器能否和新的接收机对频?

答: 可以, 对频的时候会发送随机的频点和ID, 遥控器将会用此频点和ID进行通讯, 之前对频的接收机将会失效, 需要重新对频。

13: 遥控器蜂鸣器警示音如何定义?

答: 三短声-开机提示音; 四短声-对频成功;

急促持续短声-电量不足; 缓慢持续短声-接收机未打开或断链;

三、保养、维修

长期停放时的维护、保养

将遥控器存放于干燥通风处, 减少阳光直射以防止电池过热。若需存放超过三个月, 则推荐的存放温度区间为22摄氏度至28摄氏度。切勿将电池存在于低于零下20摄氏度或高于45摄氏度的场所。

四、运输、储存

警告

为避免可能的伤害和损失, 务必遵守以下各项:

由于线材和小零件可能对儿童造成危险, 所以务必让儿童远离遥控器的部件。

注意

1) 切勿让遥控器浸入水中, 若入水, 请及时用松软干布擦拭, 并立即关闭电源。

2) 禁止机械撞击、碾压、刺穿电池, 禁止将电池跌落;

五、其他

扫描以下二维码下载并安装APP, 如无法下载, 请登录www.skydroid xin



设备助手



云卓FPV



云卓地面站

设备助手——用于调节遥控器内部参数、升级固件、保存模型、切换手型等。

云卓FPV——用于连接云卓图像部分, 可显示图像, 可悬浮在其他app上方(需打开安卓的悬浮窗功能), 可实现VR、录像、调整码流等。

云卓地面站——根据tower4.0进行优化得到, 用于连接apm、px4等mavlink协议的飞控。实现航点数据遥测, 并有视频串口(类似djigo)。

注意

如果想用QGC, 需要用有线连接云卓FPV并打开悬浮, 然后启动QGC, 选择使用蓝牙连接telemetry。后期如果QGC加入云卓sdk, 那么就会和云卓地面站一样不用使用蓝牙, 也不用另一个app悬浮在QGC, 很简单。

推荐使用云卓地面站。



QQ群



微信公众号



新浪微博



优酷平台

说明书如有更新, 恕不另行通知, 请持续关注官网www.skydroid xin

SKYDROID 云卓

泉州云卓科技有限公司



官网二维码

泉州云卓科技有限公司

www.skydroid.xin